

LEMI 4

cod. 105

Lemi
ITALIAN WELLNESS EQUIPMENT

BEAUTY



Focus on

- 4 electric motors for height, backrest, seat and the trendelenburg position adjustment
- Standard flat mattress
- Standard hand set control with automatic reset function
- Entirely enclosed ABS casing

Focus on

- 4 motori elettrici per regolazione di altezza, schienale, gamba e trendelenburg
- Materasso piatto di serie
- Pulsantiera standard con funzione di azzeramento automatico
- Carter in ABS completamente chiuso

Dimensions / Dimensioni

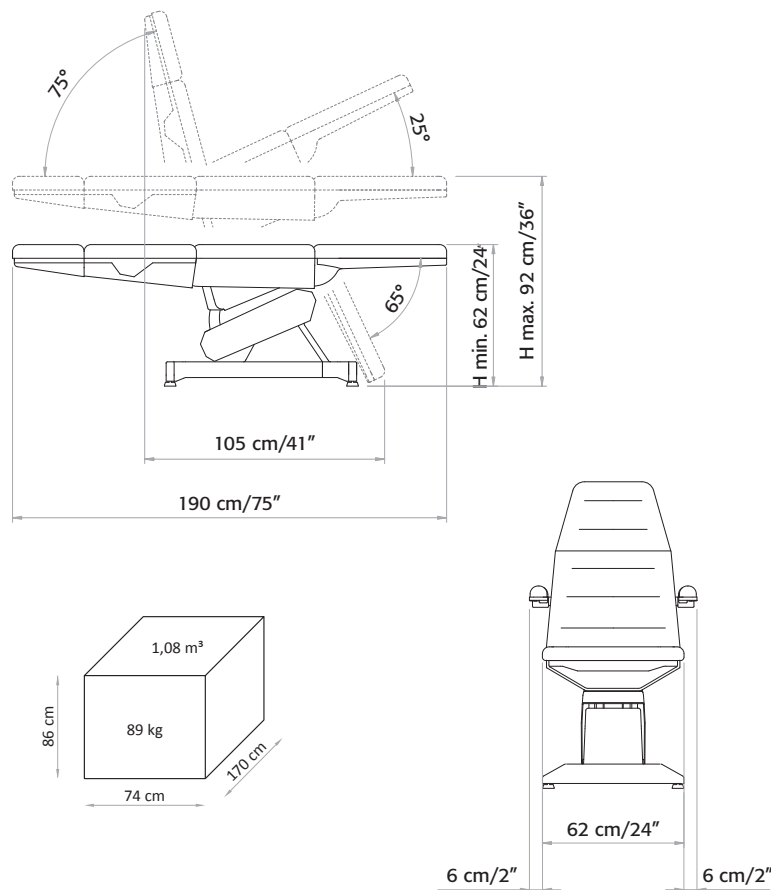

Finishing / Finiture



- White / Bianco
- Grey / Grigio
- Black / Nero



SPA PRESTIGE COLORS



9916



1424



1423



1422



2202

COLORI SPA PRESTIGE



2204



7022



7023



1875



1530

NEFOS COLORS

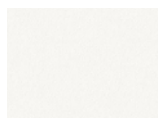

6

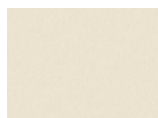

1155

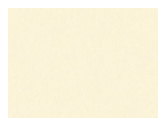

1182

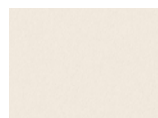

1957

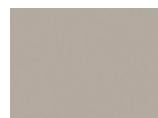

6985

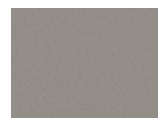

3962



2124



2146



1194



6986



64



71



2173



1388



667



680



569



1843



1868



6942



6941



5946



6940



4942



1305



991

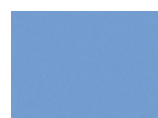

8009



8019

COLORI NEFOS

ACCESSORIES UPON REQUEST

ACCESSORI SU RICHIESTA



cod. 006
Manicure bowls
couple (for flat armrests only)
Coppia bacinelle manicure



cod. 208M
Flat armrests couple

cod. 107XL
Flat armrests couple
for XL mattress

cod. 107
Only for black plastic covering



cod. 114 P
Mattress protection
with polyurethane
Coprilettino materasso



cod. 115 P
Zak cover with polyurethane
Coprilettino materasso Zak



cod. 109
Anatomic mattress
Coprilettino materasso Zak



cod. 100
Extra comfort mattress with
memory foam
Materasso extra comfort
con Memory



cod. 112
Option for Bi-Zak
mattress (foot and head)
Materasso testa e piedi Bi-Zak



cod. 111
Zak version available instead of
Bi-Zak version
Versione Zak in alternativa alla
versione Bi-Zak



cod. 111-P
Small ZAK headrest
Testa Zak piccola



cod. XL 70
Mattress XL 70 cm
Materasso XL 70 cm



cod. ROT
Option for 180° rotation
Opzione rotazione 180°



cod. LEM-067
Foot pedal control
Pedaliera



cod. LEM-180
Wireless foot pedal control
(NO foot pedal with cable and NO remote control can be fixed)
Pedaliera Wireless



cod. 108
Roll Holder (66 cm)
Portarotolo (66 cm)



cod. 108 XL
Roll Holder (75 cm) only for
XL mattresses
Portarotolo (75 cm) solo per
materasso XL



cod. PROT. GAMBE
Plastic leg cover
Proteggi gambe



cod. 180 L
Two sections heating
Riscaldamento a due settori



cod. 118
Paper roll
Rotolo di carta



cod. LEM-139
Wheels with brake (ø 50 mm)
Ruote con freno



cod. 183
Strip headrest
Testa strip (solo per Zak/Bi-Zak)



cod. PED-V01
Pedicure basin with support
Vaschetta pedicure con supporto



cod. 311
I.V. Rod (to be fixed with fixed clamp and guides on the back)
Asta portaflebo (da fissare con morsetti girevoli e guide schiena)



cod. 314
Blood sample taking armrest couple (to be fixed with fix clamp and guides on the seat)
Coppia braccioli da prelievo con snodo (da fissare con morsetti fissi e guide seduta)



cod. 313
Medical armrest couple (to be fixed with rotatable clamp and guides on the back)
Coppia braccioli medicali (da fissare con morsetti girevoli e guide schiena)



cod. 334
Seat guides couple
Coppia guide seduta



cod. 335
Back guides couple
Coppia guide schiena



cod. 345
Fixed clamps couple
Coppia morsetti fissi



cod. 346
Rotatable clamps couple
Coppia morsetti girevoli



cod. LEM-151
Heel support couple (to be fixed with fix clamp and guides on the seat)
Coppia reggitalone (da fissare con morsetti fissi e guide seduta)



cod. 318
Thigh supports couple (to be fixed with fix clamp and guides on the seat)
Coppia reggicose con snodo (da fissare con morsetti fissi e guide seduta)



cod. 315
Curtain holder (to be fixed with rotatable clamp and guides on the back)
Reggitelo (da fissare con morsetto girevole e guide schiena)



cod. 182
Anto head rest for hair transplantation
Testa Anto per trapianto capelli



cod. 354
Inox tray with support (to be fixed with fixed clamp and guides on the seat)
Vassoio inox completo di telaio (da fissare con morsetti fissi e guide seduta)



cod. LOGO
Customized mattress with logo
Personalizzazione materasso con logo

	voltage voltaggio	frequency frequenza	absorption assorbimento	warranty	garanzia
LEMI 4	230/110V ac	50/60 Hz	0,70-1,5 Amp	structure: 10 years motors and controls: 2 years undeformable foam: 5 years heating: 1 year	struttura: 10 anni motori e controlli: 2 anni gomma indeformabile: 5 anni riscaldamento: 1 anno

REGULATIONS

All Equipment is **CE** marked

Electrical equipment and beds

Directive 2006/42/CE (Machinery Directive) and national regulations | Directive 2004/108/CE (Electromagnetic Compatibility Directive) and national regulations

NORME

Tutte le attrezzature sono a marchio **CE**

Attrezzature e lettini elettrici

Direttiva 2006/42/CE (Direttiva Macchine) e disposizioni nazionali di attuazione | Direttiva 2004/108/CE (Direttiva Compatibilità elettromagnetica) e disposizioni nazionali di attuazione